



Product size

Packing list in	Quantity
Ceiling Mount Lamp	1X
 φ6 Plastic expansion	3X
 3x30 Screw	3X

### Summary

This product is concise, easy, small size, longlife time ,etc), It is mainly used in home, bedroom, office buildings, classrooms, corridors and other space for the 4m story about places of lighting.



Use high quality White frosted glass chimney.Strengthen the flexible refraction of light.And its function of anti-ultraviolet makes the shade not easy to turn yellow and be broken.



### Specifications

Power source: 100-130V/AC   
220-240V/AC   
Power frequency: 50/60Hz

Rated load: 60W Max./E27  
Weight: about 1.22kg  
Installation sit: ceiling mount

### Installation



### Warning!

1. Please keep it away from the children.
2. Please avoid fire/high temperature/damp places for installation.
3. Please confirm when shut off the power cord access.

**Note:**Please bring the following tools.



Pencil

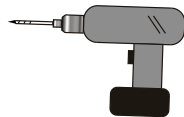

Electric drill

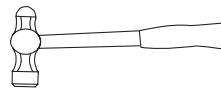

Hammer

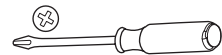

Screwdriver

- Step1 Rotating chimney down chimney(as follow: the product should be separated into two parts as A and B)

NOTE: Chimney is fragile, please don't take too much force.

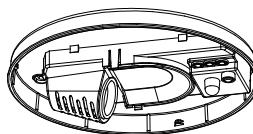
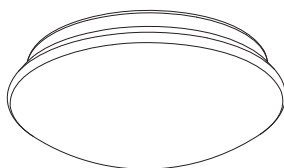

A

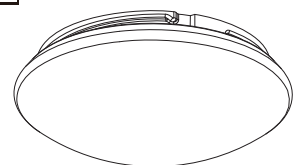

B

Fig.1



- Step2 Put the base of the product on the ceiling to make the drilling mark (as Fig.2)

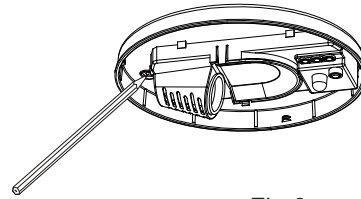
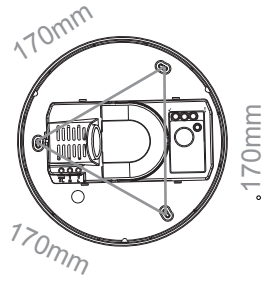

Fig.2

- Step3 Install the product on the place where you marked (as Fig.3)
- Step4 Knock the plastic expansion into the hole which you drill (as Fig.4)

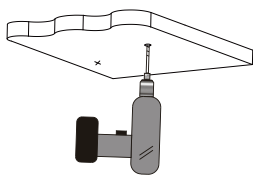

Fig.3

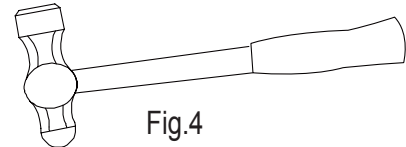
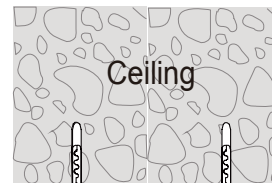
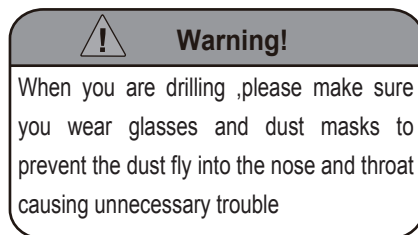

Fig.4

- Step5 Put the power line through the line hole to connect on the wiring (as Fig.5)

**Warning!** Please confirm when shut off the power cord access.

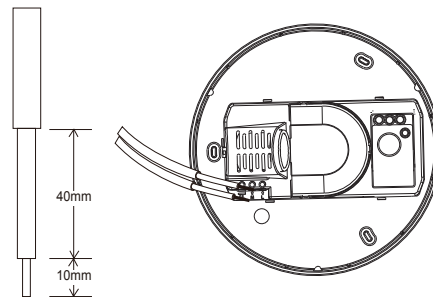
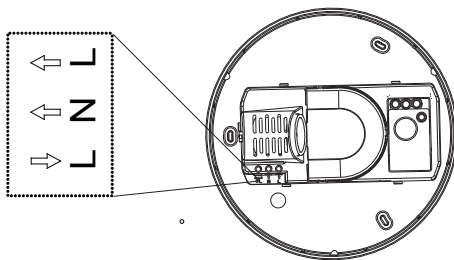

Fig.5

- Step6 Fix the base of the product on the selected place with the screws (as Fig.6)

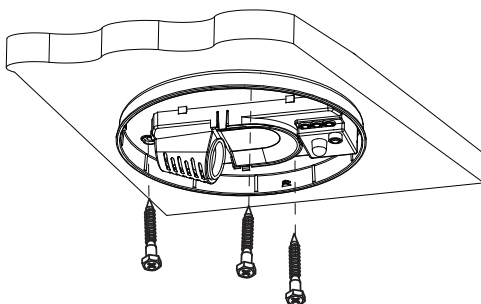
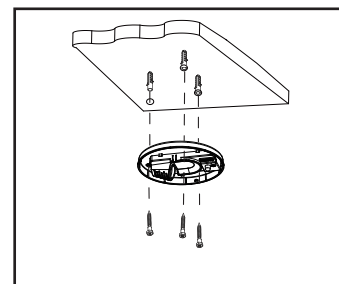
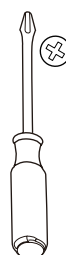

Fig.6



Concrete ceiling

- Step7 Will rotate, cover chimney on base (as Fig.7)

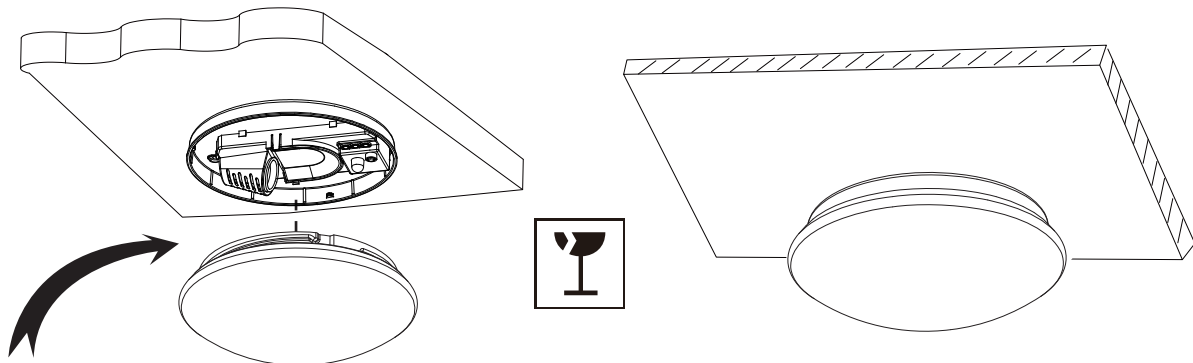

Fig.7



**! Warning!**

- Please confirm with professional installation.
- Please cut off power supply before installation and removal operations.
- Make sure that you have cut off the power for safety purposes.
- Improper operation caused losses, the manufacturer does not undertake any responsibility.

We are committed to promoting the product quality and reliability, however, all the electronic components have certain probabilities to become ineffective, which will cause some troubles. When designing, we have paid attention to redundant designs and adopted safety quota to avoid any troubles.

This instruction, without our permission, should not be copied for any other purposes.